



ControlNet Training Lab Exercises

What's in These Lab Exercises?

This document contains eight lab exercises that explain the features of ControlNet™ release 1.5. The following table describes where to find specific information.

For information about	See page
hardware setup	3
configuring the ControlNet network	9
assigning I/O devices to processors	14
multicast discrete inputs	23
analog I/O	25
multicast analog	26
scheduled peer communications	27
communicating on ControlNet using ladder instructions	31

What We Assume

We assume that you are using the hardware setup as shown in lab 1 to complete these lab exercises. We also assume you have a computer with RSLinx™, RSNetworx, and RSLogix5 software loaded.

Prepare for the Lab

Make note of the following conditions in preparation for the lab exercises.

- The computer is attached to the ControlNet network through a 1784-KTCX15 ISA bus card.
- The PLC-5® chassis is set to 1-slot addressing. The 1771-ACN(R)15 I/O chassis is set to ½-slot addressing.
 - Important:** Your lab may be equipped with either a 1771-ACN15 and 1794-ACN15 or a 1771-ACNR15 and 1794-ACNR15 I/O adapter. These modules are identical except the 1771-ACNR15 and the 1794-ACNR15 permit redundant media operation, an operation not covered in these exercises. Throughout these lab exercises, 1771-ACN(R)15 and 1794-ACN(R)15 refer to both the singular and redundant adapters, whichever is applicable to your lab.
- The 1794-IE4XOE2 FLEX I/O™ analog module is used for these lab exercises. There are two series of this module (A and B) which behave differently. The ladder logic in the NODE2.RSP file allows the lab to work with either a series A (1794-IE4XOE2/A) or series B (1794-IE4XOE2/B) module. However, you must select the correct module from the module list when entering the ControlNet configuration or the module will not communicate. We will indicate when to select the appropriate module. Your lab instructor will have to tell you which modules are being used in this particular class.

- Two **RSLogix5** project files are used to load ladder logic into the processors. The ladder logic helps display the features of ControlNet. We pre-programmed the ladder logic for you since the focus of this lab is on the ControlNet network. The ladder files do not need to be preloaded into the PLC processor. We will instruct you to load the files at the appropriate time. The two files are:

- NODE1.RSP (for processor at node 1)

- NODE2.RSP (for processor at node 2)

Common Techniques Used in These Lab Exercises

The following conventions are used throughout these exercises:

- Bulleted lists provide information, not procedural steps.
- Numbered lists provide sequential steps.
- Information in **bold** contained within text identify menu options, screen names and areas of the screen, such as dialog boxes, status bars, radio buttons and parameters.
- Text in **this font** identify actions you perform.
- Text in *this font* identify node addresses and other values assigned to devices.
- Text in `this font` identify keyboard keys you should press.
- Pictures of screens represent the actual screens you use.



ATTENTION: Identifies information about practices or circumstances that can lead to personal injury or death, property damage or economic loss.

Attention statements help you to:

- identify a hazard
- avoid the hazard
- recognize the consequences



We use this convention to call attention to helpful information.

Important: Identifies information that is critical for successful application and understanding of the product.

Lab 1: Hardware Setup

What Your System Will Look Like

At the completion of this lab, your system will look like this drawing.

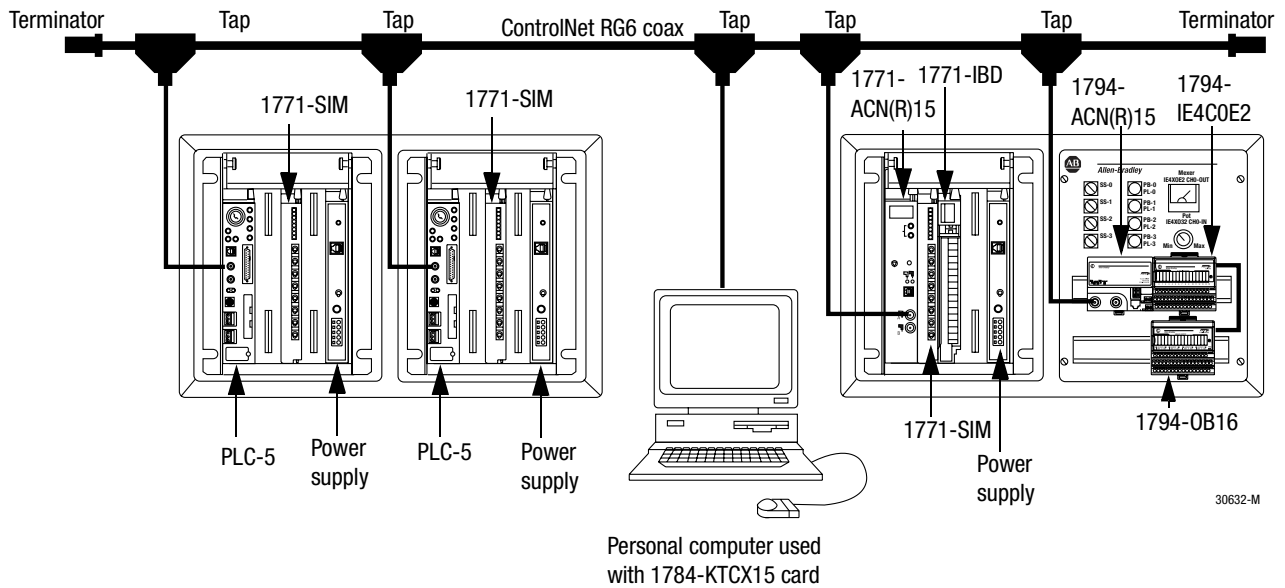

Describe the Hardware

Following is a brief description of each piece of hardware.

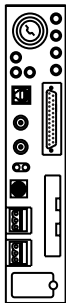

40939

- **ControlNet PLC-5 Processor**
The PLC-5 is used for control information processing. It offers high-speed communication through a ControlNet port. You can have multiple ControlNet PLC-5 processors on a ControlNet network. Each processor controls its own I/O on the network, and at the same time, communicates with the other processors. Also, input data may be shared among multiple processors.



40940

- **1771-Simulator Module (1771-SIM)**
The Simulator Module has eight dedicated inputs for eight toggle switches and eight dedicated outputs for eight indicators built into its front panel. Use the eight panels to simulate other open/close devices.

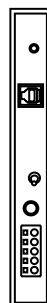

40941

- **1771-P4S Power Supply**
The 1771-P4S power supply is used in 1771 Universal I/O chassis. It provides 5V dc power directly to the chassis backplane. These power supplies occupy one or two slots and can provide up to 8 amps per supply to the I/O chassis. The modules can be paralleled to provide up to 20 amps per chassis at 60 degrees celsius or up to 24 amps per chassis at 55 degrees celsius.

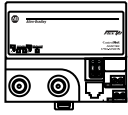

40942

- 1794-ACN(R) adapter
The ControlNet FLEX I/O adapter contains a built-in power supply that converts 24V dc to 5V dc for the backplane to power the FLEX I/O modules. All FLEX I/O modules are supported by the ControlNet FLEX I/O adapter. The 1794-ACNR has a second BNC connector that permits redundant media operation.



41259

- 1794-IE4XOE2
The 1794-IE4XOE2 is an analog I/O module. It has four single-ended inputs and two single-ended outputs, a backplane current load of 20mA, and it requires +24V dc external power.



41260

- 1794-OB16 FLEX 16 pt. output module
This 16 output module has 1.0mA minimum and 500mA maximum continuous current per output. It has 8A maximum currents per module and an 80mA backplane current load.

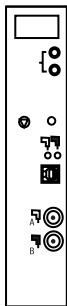

41261

- 1771-ACN(R)15
This ControlNet 1771 I/O adapter module interfaces the 1771 I/O modules with the PLC-5 across the ControlNet network. The 1771-ACNR15 has a second BNC connector that permits redundant media operation.

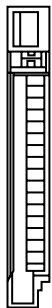

41262

- 1771-IBD
The 1771 digital dc input module is compatible with source-switching devices. It has a 10-30 operating voltage, maximum off-state current of 2.0mA, 16 inputs, and a backplane current load of 250mA.

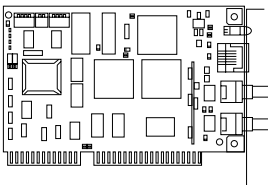

41263

- 1784-KTCX15 Communication Interface Card
The ControlNet ISA and EISA bus interfaces let your 16-bit ISA- or 32-bit EISA-compatible computer communicate on a ControlNet network. This interface card has diagnostic status indicators, redundant media BNC connectors, and an RJ-45 connector.

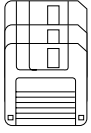

41264

- **RSNetworkx, RSLinx, and RSLogix5**
Software used to configure ControlNet and ControlNet devices, communicate over the network, and create ladder logic programming.

Each station will have its own network of two PLC-5s, one 1771-ACN(R)15 adapter, one 1794 FLEX I/O adapter, and one 1784-KTCX15 card. The following steps show you how to set up your system so it matches the drawing.



ATTENTION: Please follow the steps listed in the lab. There will be several items pointed out as you go through the lab which you may not notice if you just work from the drawing or attempt to complete the lab on your own.

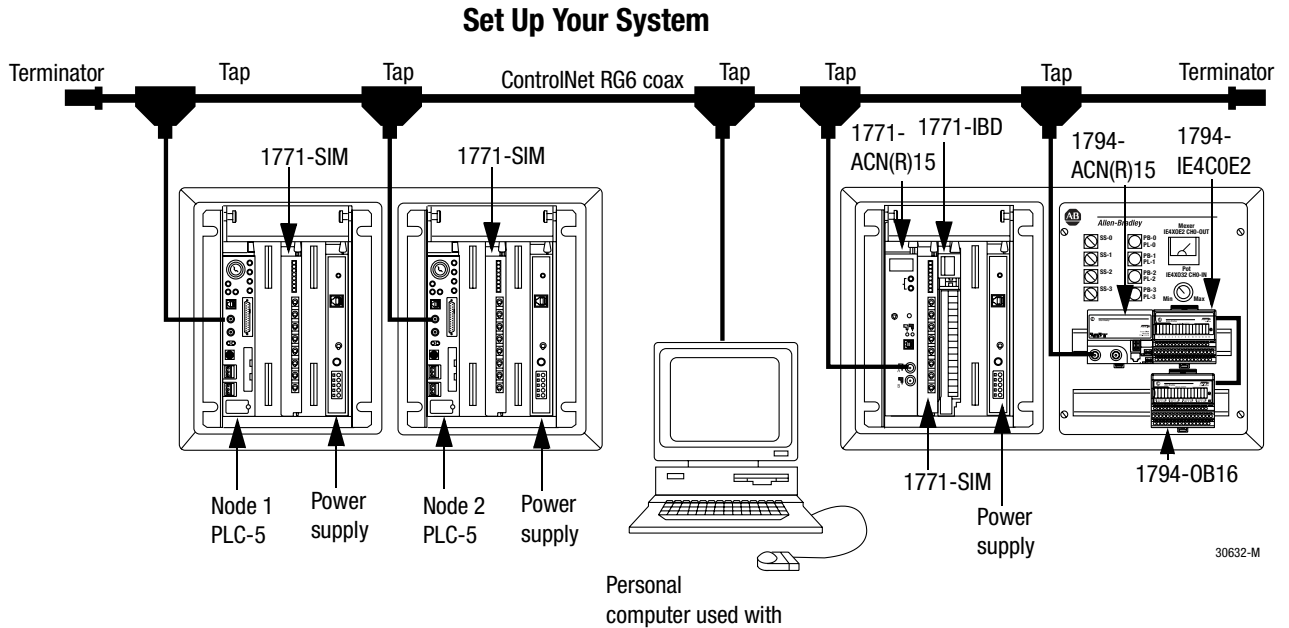

The drawing has been repeated here to aid you in setting up your system. Make sure you have all the equipment as shown in the drawing.

Important: Turn power off all chassis.

1. Remove the PLC-5s and 1771-ACN(R)15 from the chassis. Set the rotary switches on the top of the modules to the following node numbers:
 - PLC-5 (left chassis): node *1*
 - PLC-5 (right chassis): node *2*
 - 1771-ACN(R)15: node *3*

Important: Notice that the rotary switch which represents the tenth digit of the station number has two digits displayed. This prevents any confusion as to which switch represents the tenths digit of the address. The station number can be read directly as you set the switches. There is no need to hunt for manuals or decipher dip switch conversion charts.

2. The FLEX I/O adapter should be set to address *04*. Examine the front of the FLEX adapter to be sure the address is set to 04. If it is not, set the address to 04 and cycle power on the FLEX adapter by removing the power cord from the coordinated demo chassis.

The PLC-5 with node address 1 stores all the network information configured in **RSNetWorx**. Currently, a PLC-5 is the only device which is capable of storing the network information. Therefore, a PLC-5 must exist at node 1 on a ControlNet network. This means that a PLC-5 at node 1 must exist on the network whenever network changes are made. If a network is running and the PLC-5 at node 1 faults, the network will continue to run. However, node 1 must be brought back on line to make any network changes.

In the near future, devices other than a PLC-5 will be capable of storing the network information. For example, the 1756-CNB module (ControlLogix ControlNet interface) will support node 1 capability at release.

3. Plug the PLC-5s and 1771-ACN(R)15 adapter into their respective chassis.
4. Connect a tap to the PLC-5s, 1771-ACN(R)15 adapter, and FLEX adapter.
5. Connect the coax cable to the taps to form a trunkline/dropline configuration. Wire the system as shown in the drawing on the previous page.
6. Connect a tap to the 1784-KTCX15 card in the computer and connect the tap to the trunkline.
7. Terminate the ends of the trunk. (The integrated demo boxes are already terminated. If you position each demo box at either end of the trunk, you will not need to move terminators.)
8. Disconnect the tap on the front of PLC-5 node 1 and then turn on power on the chassis with PLC-5 node 1 in it.
9. Examine the two LEDs above the ControlNet channel. Both LEDs will blink red. ControlNet defaults to redundant cabling (channel 2A and 2B). The left LED is for channel A; the right LED is for channel B. These LEDs are the network health LEDs and give an indication of the physical network's health. Currently, since the PLC-5 is the only station, there is no valid network.
10. Turn on power to all devices and then connect the tap to the front of the node 1 PLC-5.
11. Examine the processor LEDs above the ControlNet channel. The channel 2A LED is now solid green (channel 2B LED will still blink red). If your system is not behaving in this manner, ask a lab assistant for help.

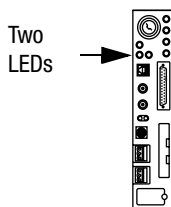

40939

The physical network is now valid for channel A. There are five devices, with the proper taps, and the network is terminated correctly.

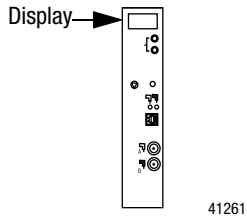

12. Examine the display on the 1771-ACN(R)15. The display should switch between "IDLE" and "A#03". IDLE means the adapter is initialized but there are no open connections to the adapter (no device is trying to control the I/O in its chassis). A#03 means the device is address number 3 on the ControlNet network.

During normal operation, the 1771-ACN(R)15 adapter displays its address on the front of the module. This way, you don't have to pull the adapter to verify the address setting or wonder at what address the device is set.

13. Disconnect the drop cable to the 1771-ACN(R)15 adapter.

14. Examine the display on the adapter. The display should alternately read "NET ERR" (network error) and A#03. The adapter display provides a wide range of diagnostic messages. If your system is not behaving in this manner, there is a problem somewhere. Ask a lab assistant for help.

15. Reconnect the drop cable to the 1771-ACN(R)15 adapter.

16. The ControlNet LEDs for channel A on both the PLC-5 and the 1771-ACN(R)15 adapter should be solid green and the adapter display should be switching between "IDLE" and "A#03". The COMM LED on the FLEX adapter should be solid green. The STATUS LED on the FLEX I/O adapter should blink green to indicate there are no communications open to the adapter. If your system is not behaving in this manner, ask a lab assistant for help.

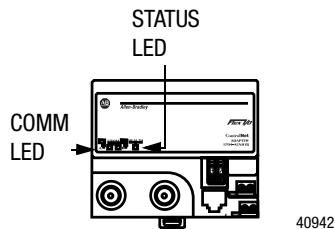

LAB 2: Configure the ControlNet Network

Configuring a ControlNet network is easy using the **RSNetworkx** Network Management Software by taking advantage of the drag and drop features of Microsoft® Windows 95® and Windows NT™. To add devices to a network, you simply select the desired device from the hardware list and drop it onto the network drawing.

If you are configuring the network on line, you can simply tell the software to automatically find the nodes on the network. When you have added all of your devices, you will have a nice graphical view of the network as shown below.

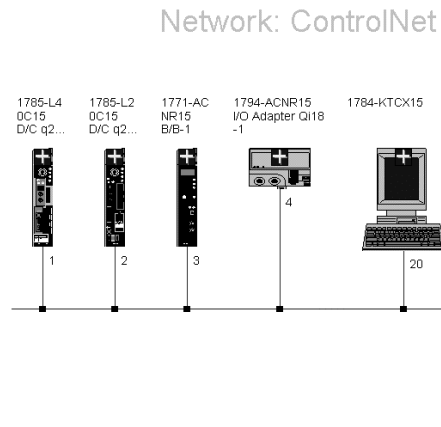

Once your network drawing is complete, you can set the network and physical media parameters with a simple point and click on the network display with the left mouse button which will bring up the property pages for the network.

For this lab, we will work on line so that we can use the auto-network feature.

Important: Make sure both PLC-5s are in program mode before you begin editing. When performing edits, the software must obtain the edit resource. The edit resource can only be obtained if the PLC-5 (or PLC-5s) are in program mode.

1. Double click on the shortcut to RSNetworkx icon in the ControlNet folder on the desktop to start the **RSNetworkx** software. The icon is shown below.



You see this screen.

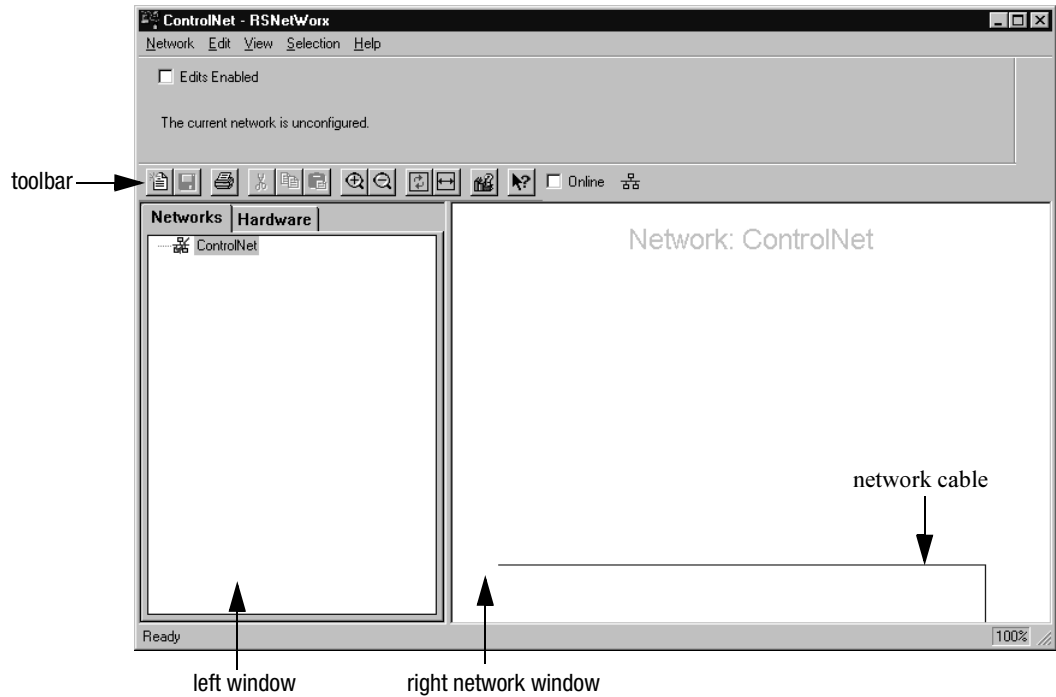

The screen on the left shows the networks you currently have configured. Since we have not configured a network yet, we only have a default ControlNet network. The screen on the right (the Network Window) shows a graphical view of the network. At this time, we only have the network cable itself; there are no devices.

Establish a Path to Go On Line

The first thing you want to do is go on line (the software comes up in offline mode with the last file open, which in our case is a default file). To go on line the first time, you have to tell **RSNetworx** the “path” you want to use to go on line. A path is established by telling **RSNetworx** which communication driver you wish to communicate through in **RSLinx** (note the drivers must already be set up in **RSLinx**). Let’s establish the path.

1. Click on the **Online** check box to the right of the toolbar.



You see the **Browse for Network** screen.

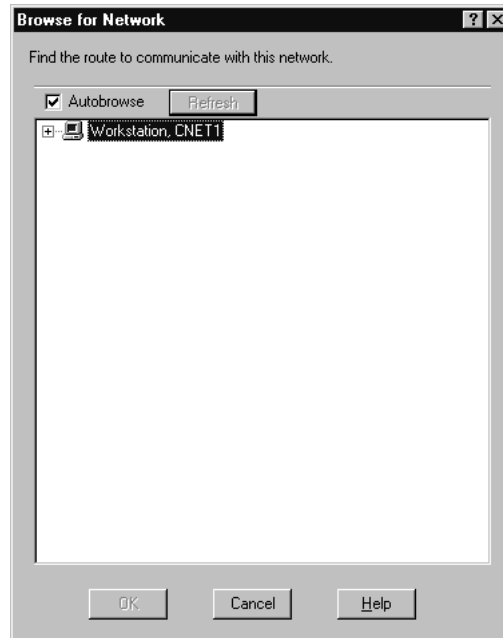

Your computer's name displays in the **Browse for Network** screen (the actual name of your computer appears instead of "computername"). This is the computer name entered in the network configuration of your operating system.

2. Click on the "+" next to the computer in the **Browse for Network** screen.

The available drivers configured in **RSLinx** appear below the computer name as shown below. (Additional driver options may appear on your screen.)

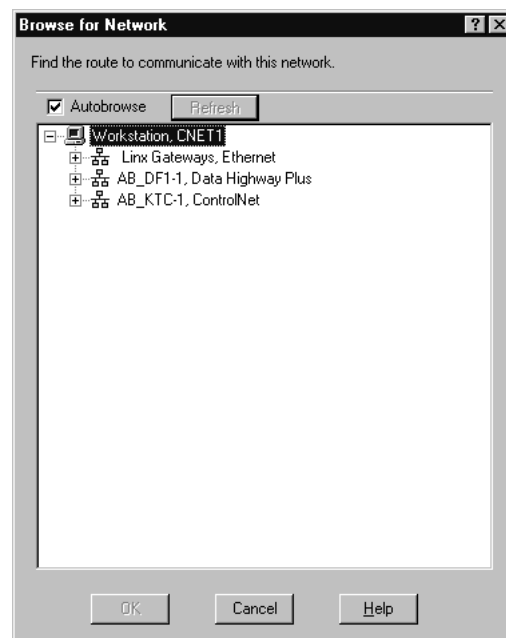

- Click on the driver **AB_KTC-1 (ControlNet)** (Windows NT) or **AB_KTC95-1 (ControlNet)** (Windows 95) and then click on **OK** to establish the communication path.

The computer goes on line and all nodes currently connected to the network appear in the network screen.

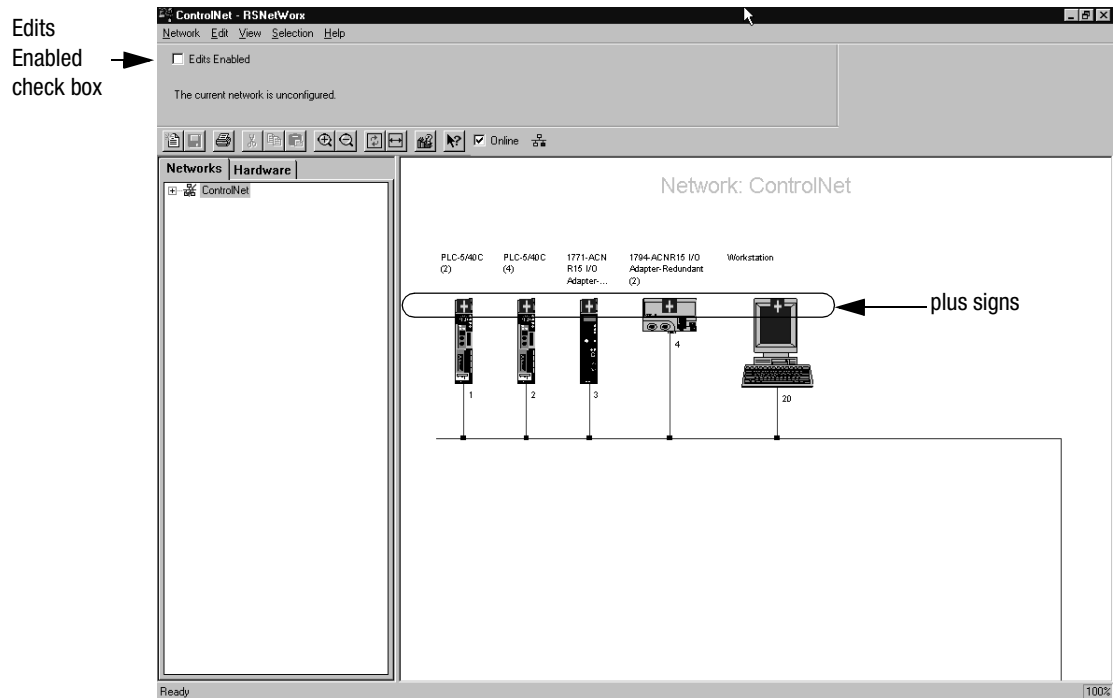

Note the nodes with the “+”. The “+” indicates a node which is on the network but has not yet been saved to the configuration file. You are now ready to configure the network parameters.

Configure Network Parameters

To configure the network, you enter values for parameters such as the Network Update Time (NUT), Maximum Scheduled Address, Max Unscheduled Address, and Media Redundancy.

Follow these steps to configure the network parameters.

- Place the cursor over the Network screen (the screen on the right where all the nodes are displayed).
- Press the right mouse button. A pop-up menu appears.
- Click on **Enable Edits**.



You can also check the **Edits Enabled** check box in the upper left part of the screen.

- After the edits have been enabled, press the right mouse button again. (Your cursor should still be in the Network screen.) A pop-up menu appears.

- Click on **Properties**. The **Network Properties: ControlNet** window appears. There are three tabs, the first of which is the Network Parameters tab.

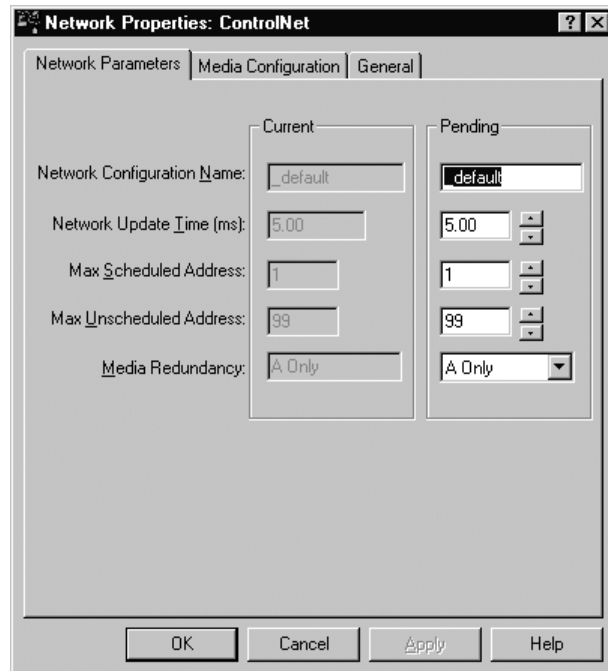

- Change the pending max unscheduled address to **20**. This defines node address 20 as the highest address which can use unscheduled bandwidth.

Important: Make sure your 1784-KTCX15 card is configured to node address 20 or below. If your 1784-KTCX15 is configured for a higher node number, you will have to increase the max unscheduled address setting to include your KTCX15 node number in the unscheduled node range.

- Set the pending max scheduled address to **4**. This defines node address 4 as the highest address which can use scheduled bandwidth.
- Enter a name (up to 30 characters) for the network configuration.
- The rest of the parameters will remain at their default values. Click on the **OK** button to accept the parameters. This will also take you back to the Network screen.

▶ Selecting **OK** applies the edits and then closes the window. Selecting **Apply** applies the edits but leaves the window open for further editing.

10. Save the configuration by clicking on **Network** from the main menu and then clicking on **Save** from the pull-down menu; or click on the **Save** icon on the toolbar as shown below.



You see the **Save Configuration** prompt dialog box.

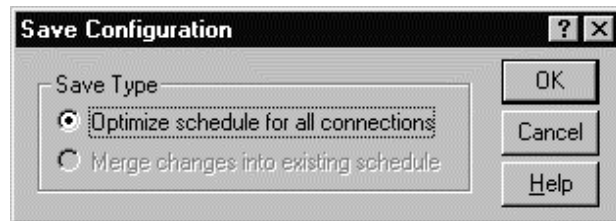

11. Click on **OK** to the prompt to optimize schedule for all connections.
12. Enter a name for the file and click on **Save**.

When the save is complete the “+” signs disappear indicating the nodes are now saved as part of the configuration.

The network configuration is now complete. You have a five node ControlNet network configured and communicating.

Note the channel B LEDs on all the devices are now off. You configured the network to use channel A only so the channel B LEDs were turned off. This completes the network configuration lab.

Next you will configure each node to define what data to produce on or consume from the network.

LAB 3: Assign I/O Devices to Processors

ControlNet supports multiple processors on the same network, each controlling its own I/O. It's very easy to identify with which I/O devices you would like a particular processor to communicate. The process of identifying how a particular processor communicates with I/O devices is called mapping.

The goal of this lab is to have the PLC-5 processor at node 1 communicate with the 1771-ACN(R)15 I/O chassis at node 3, and the PLC-5 processor at node 2 communicate with the 1794- I/O rack at node 4. To do this, you must map the 1771-ACN(R)15 chassis in the PLC-5 at node 1 and map the 1794-ACN(R)15 chassis in the PLC-5 at node 2.

Let's start by mapping the 1771-ACN(R)15 chassis into the PLC-5 at node 1.

Map the 1771-ACN(R)15

1. Move the cursor over the node 1 PLC-5 icon in the **RSNetworkx** Network window. The node 1 PLC-5 is the device with a **1** below it.
2. Click the right mouse button. A pop-up menu appears.
3. Click on **ControlNet Configuration**.

You see the **Node 1 - PLC-5 ControlNet Configuration** screen as shown below. To verify you are in the PLC-5 ControlNet Configuration tool for node 1, look at the bottom right corner of the screen. The display should read "Node 1". The processor you are configuring will be highlighted by a green bar in the map table.

map table →

Monitor status → display of Node 1 →

Node	Slot	Message	Module/Message Type	API(ms)	RPI(ms)	Connection Type	Input Address	Input Size	Output Address	Output Size	Status Address
			PLC-5/80C								
2			PLC-5/80C								
3			1771-ACNR15								
4			1794-ACN15								
20			1784-KTCX15								

The upper portion of the screen contains status information regarding the amount of available resources used in the map table. The map table itself is the table in the middle of the screen with the white background. The bottom of the screen contains user input fields which allow you to identify which files to use for entries in the map table. We will take a closer look at the various parts of The ControlNet configuration tool during the labs.

You are now ready to begin editing the map table.

Edit the Node 1 PLC-5 ControlNet Configuration

Follow these steps to edit the PLC-5 ControlNet configuration.

1. Click on the **Network** option (upper left corner) of the main menu.

Notice the “Monitor” status on the bottom right part of the screen.

2. Click on the **Enable Edits** option on the **Network** menu. Notice that the status in the lower right of the screen changed from “Monitor” to “Edit”.

The first thing we want to do is identify the files which will store the various types of data used in the map table.

3. Move the cursor down to the **Status File** box in the lower left of the screen.
4. Click in the **Status File** box and then enter *N11*. This selects N11 as the file to store the status information in the PLC-5 for each of the entries in the map table. The status file contains information on the state of communications (e.g., success, faulted).

We will also choose Configuration, Data Input, and Data Output files.

- The configuration data used in the map table is stored in the Configuration file.

- The Data Input file (DIF) is used for:

- storing data from scheduled messages received from other devices, and
- reading information from intelligent devices such as analog input modules or drives

- The Data Output file (DOF) is used for:

- storing data for scheduled messages that are to be written to other devices, and
- writing information to intelligent devices such as analog output modules or drives

Important: The Data Input and Data Output file can be used for discrete I/O. If you use the Data Input and Data Output files for discrete, be aware that the I/O in these files cannot be forced.

You can use any integer file (N file) in the PLC-5 processor to act as the Status, Configuration, Data Input, or Data Output files. However, if you are upgrading a system from an earlier ControlNet phase, make sure you use the same files as was previously entered.

5. Press the Tab key to move to the **Configuration File** box.
6. Enter **I4** for the Configuration File.
7. Press the Tab key to move to the **Data Input File** box.
8. Enter **I2** for the Data Input File.
9. Press the Tab key to move to the **Data Output File** box.
10. Enter **I3** for the Data Output File.

Map the I/O Devices

You are now ready to begin mapping the I/O devices to the processor. Notice that the map table currently has 5 items listed. These are the 5 devices on our network. Note that there is no information next to any of the devices at this time. This is because none of the devices have been mapped yet. If a device in the map table does not have any information next to it, then it has not been configured to communicate with the processor whose map table you are viewing.

For this lab, we have decided that we want the node 1 PLC-5 to communicate with the 1771 I/O chassis. The 1771 I/O chassis is controlled by the 1771-ACN(R)15 adapter. Therefore, in order to communicate with the 1771 I/O chassis, you must configure a map entry for the 1771-ACN(R)15.

1. Move the mouse over the **1771-ACN(R)15** module entry in the map table and press the right mouse button. A pop-up menu appears.
2. Click on **Insert Device Connection**.

The text for the 1771-ACN(R)15 changes to blue to signify a pending edit. This screen is used to identify how often you want to communicate with the device (requested packet interval - RPI), how many input and output words will be sent/received (Input Size and Output Size), and where the data will be read into (Input Address) and written from (Output Address).

Notice the headings above the map table. The "Input Address" field defaults to I:--- and the "Output Address" field defaults to O:---. The PLC-5 processor will default to using the I/O image table for all discrete I/O. However, as noted previously, you can map the discrete I/O to the Data Input and Data Output files.

AutoMap Feature

At this point you could enter the addresses to store the data, or have the software select them for you using the “AutoMap” feature. The AutoMap feature will select the first unused addresses available. It will also map around any addresses used on other channels, such as I/O connected to a remote I/O channel.

1. Right click on the blue text.
2. Move the cursor to the **Auto Map** option of the pop-up menu and choose **All Entries**. Notice that the input and output addresses were automatically filled in for the 1771-ACN(R)15.

At this point we could set input and output sizes and adjust the RPI. But for this lab, you will use the defaults of 8 words for the sizes and 5 ms for the RPI.

You have completed mapping PLC-5 node 1. You have just set up the PLC-5 to exchange 8 words of input data and 8 words of output data every 5 ms with node number three 1771 chassis. You will now go to the PLC-5 at node 2 and set it up to communicate with node 4.

Map Node 2 PLC-5

1. Move the cursor over the node **2 PLC-5/40C** entry in the map table and right click the mouse button. A pop-up menu appears.
2. Click on **Display ControlNet Configuration (node 2) window**.

The ControlNet Configuration tool for node 2 appears. To verify you are in the ControlNet Configuration tool for node 2, check that the node 2 PLC-5 is highlighted in green in the map table.

Automap and Automodule Features

For node 2, you will take advantage of the automapping and automodule features of the software. In this processor, you will allow the software to automap everything for us, including the selections of the DIF, DOF, status and configuration files.

► DIF = Data Input File

DOF = Data Output File

A description of the purpose of these files is discussed in page 16.

The decision on where and when to use automapping is up to you. The important thing to remember is that whatever files are used in the map table, the ladder logic must correspond correctly in order for the system to work. For example, if the ladder program is already written, you will not be able to automap anything because there is no guarantee the automap feature will select any of the files which match your ladder logic.

If you are starting with a clean system, you can automap everything and then just provide the map table to the people writing the ladder logic so they choose the appropriate locations in their ladder rungs. The automodule feature simply automatically adds map entries for the devices you select.

For this lab, we have decided that we want the node 2 PLC-5 to communicate with the 1794 I/O chassis.

1. Click on the **1794-ACN(R)15** entry in the map table.
2. Click on the **Auto Module Selected Adapters** icon from the toolbar (shown below) to automatically add map entries for the 1794 adapter.

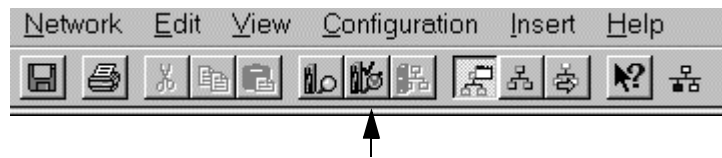

3. Choose the **1794-IE4XOE2** module in the map table.
4. Press the `Delete` key to delete the 1794-IE4XOE2 module.

You are now ready to map the discrete module map entry for the 1794-ACN(R)15.

Map the 1794-ACN(R)15

To map the 1794-ACN(R)15:

1. Click on the **Auto Map All Entries** icon (shown below) to automatically map the map entry.

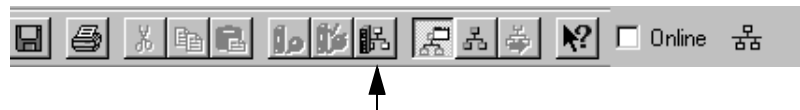

You see the following screen:

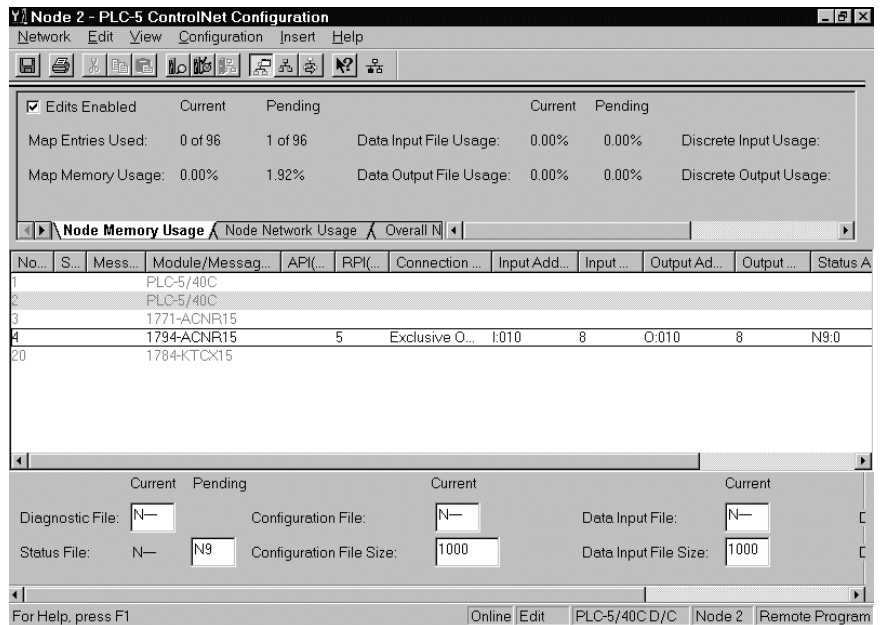

Notice that the only file which was filled in at the bottom was the status file (N9). This is due to the fact that the discrete map entry defaults to using the I/O image table for data transfer and no configuration data is needed for discrete drivers. You will see later when we add the analog modules, that the software will also add selections for the DIF, DOF and configuration files.

At this point we could set input and output sizes and adjust the RPI. But for this lab, we will use the defaults of 8 words for the sizes and 5 ms for the RPI. Let's accept the edits.

2. Click on the **Save** icon from the toolbar.

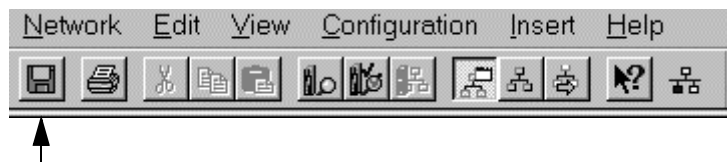

3. Click on **OK** for an optimize schedule for all connections save.

After the edits have been saved, notice that the blue edit text is replaced with gray text. Also, note that you only had to accept edits once for both PLC-5 map tables. You could have accepted edits after configuring node 1, but it is not required.

You are now finished with PLC-5 node 2. You have just set up the PLC-5 to exchange 8 words of input data and 8 words of output data every 5 ms with node number 4.

Test the Mapped Configuration

At this point we are ready to test the configuration. We will use RSLogix 5 software to download some ladder logic into the PLC-5s which will test the ControlNet configuration.

1. Start RSLogix 5 software by using the start menu to select **Programs -Rockwell software -RSLogix 5 English**, or double click on the **RSLogix 5** shortcut in the ControlNet folder on the desktop.
2. After the software has opened, click on **File** from the main menu and then click on **Open**.
3. Open **node1.rsp**.

Important: This file has been saved in the ControlNet folder on the desktop. You may have to edit the path to the ControlNet folder on the desktop.
4. Download the file by selecting **download** from the mode box in the upper left corner of the screen (currently the mode says **offline**).

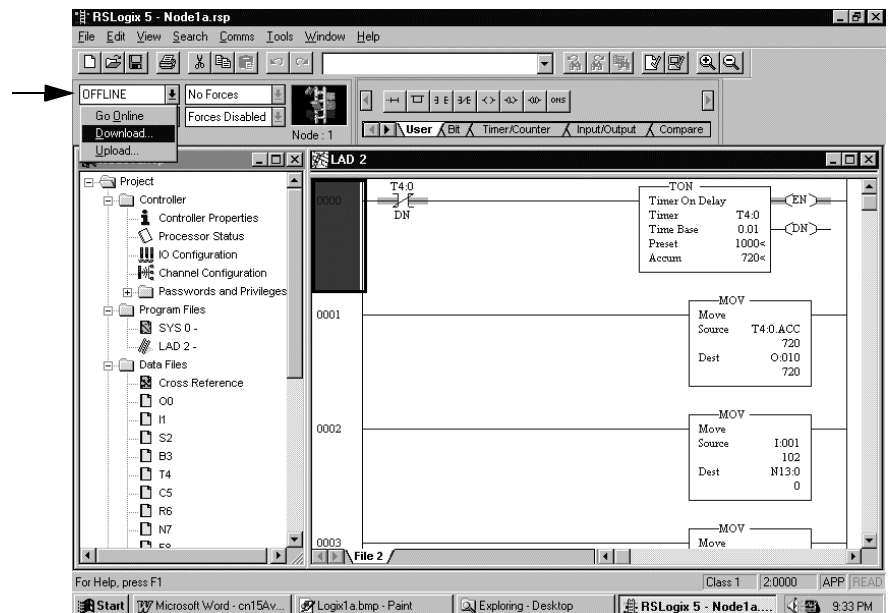

You see a warning message about processor mismatch.

5. Click on **Yes** to proceed with the download.

Important: Click on **Yes** to keep the existing ControlNet configuration information.
6. If the dialog box to confirm change processor type appears, click on **OK**.

7. Click on **Yes** to continue the download with the chosen ControlNet files.
8. Click on **Cancel** in the **Save Program As...** dialog box.
9. When you see the download complete message, click on **Yes** to go on line.

There are now rungs in the processor which will allow you to confirm you have entered the ControlNet information correctly. Now you can also download rungs to node 2 PLC-5.

Download Ladder Logic Code to Node 2 PLC-5

1. Click on **File** from the main menu and then click on **Open**.
2. Open **node2.rsp** (make sure you are looking in the ControlNet folder on the desktop).
3. Click on **Yes** to close node1a.rsp and **No** if prompted to save any changes.
4. Download the file by selecting **download** from the mode box in the upper left corner of the screen (currently the mode says **offline**).

You see a warning message about processor mismatch.

5. Click on **Yes** to proceed with the download.

Important: Click on **Yes** to keep the existing ControlNet configuration information.

6. If the dialog box to confirm change processor type appears, choose **OK**.
7. Click on **Yes** to continue the download using the current ControlNet files.
8. Click on **Cancel** to the **Save Program As...** dialog box.
9. When the download is complete, click on **Yes** to go on line.

There are now rungs in the processor which will allow you to confirm you have entered the ControlNet information correctly.

Test the Configuration after Download

You are now ready to test your configuration. If you have set up the system correctly, the 1771-SIM card module (the module with the switches and LEDs on the front) LEDs should start flashing when PLC-5 node 1 is put in run mode.

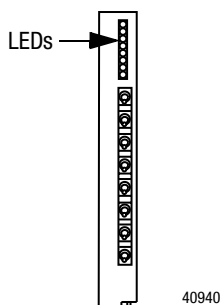

40940

1. Use the keyswitch to put PLC-5 node 1 in run mode. Observe the SIM card LEDs in the 1771-ACN(R)15 chassis. If the LEDs are not flashing, ask an instructor for assistance.

If node 2 is configured properly, the pilot lights above the 1794 FLEX I/O chassis (PL_0 to PL_3) should start flashing when PLC-5 node 2 is put in run mode.

2. Put PLC-5 node 2 (the PLC-5 on the right) in run mode. Observe the pilot lights. If the pilot lights are not flashing, ask an instructor for assistance.

If your system is behaving correctly as described, you have successfully completed the network configuration lab.

LAB 4: Multicast Discrete Inputs

ControlNet is based on producer/consumer technology. Using producer/consumer technology, a node can “produce” data on the network, and any node can “consume” that data. This differs from traditional master/slave networks which use read/write schemes with specific source and destination addresses.

With the producer/consumer technology, a node produces data and attaches an ID which identifies the data. All nodes on the network see the data and can decide whether or not they want to consume it based on the ID of the data. This allows the network to run much more efficiently.

For example, suppose a PLC detects a jam in a conveyor. Rather than that PLC having to send separate messages to all PLCs which have conveyors feeding it, each of the other PLCs could see the conveyor jam bit directly. The ability for a single input to be seen directly by multiple PLCs is referred to as multicast inputs.

As you recall from the previous lab, node 3 is currently set up to communicate with PLC-5 node 1. In this lab, we will go into the map table for node 2 and tell it to listen to the inputs coming from node 3. Therefore, the inputs from node 3 will be read from the network directly by node 1 and node 2, creating a multicast input configuration.

1. Put both PLC-5s in program mode.
2. You should still have the **Node 2 - PLC-5 ControlNet Configuration** screen open on your computer. If you do not, open the **Node 2 - PLC-5 ControlNet Configuration** screen (The node 2 PLC-5 should be highlighted in green).
3. Move the cursor over the **1771-ACN(R)15** (node 3) entry in the map table and press the right mouse button.
4. Click on **Insert Device Connection** from the pop-up menu.
5. Click on **Yes** to the prompt to switch the software to edit mode.

- After the edits have been switched, click on the **Auto Map All Entries** icon (shown below) on the toolbar.

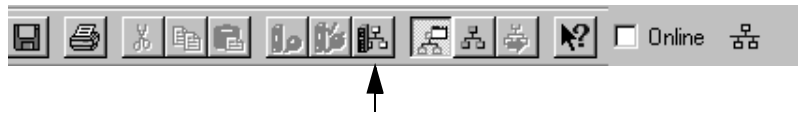

- Click on the **Network** option of the main menu.
- Click on **Save** from the pull-down menu and then click on **OK** for an optimize schedule for all connections save.

That's it! You have just set up a second PLC-5 to consume the data being produced by the 1771-ACN(R)15 at node 3. Since node 3 is a 1771 I/O chassis, the data being produced in this case is input data.

Examine the "Connection Type" field of the map table. Note that for node 4 the connection type reads "Exclusive Owner" and for node 3 the connection type reads "Multicast". This means that for node 4, this PLC is the exclusive "owner" of the outputs. This is the PLC which controls the outputs in the chassis.

Only one PLC is allowed to control outputs in a 1771 I/O chassis. For node 3, you previously set up node 1 as the exclusive owner of the outputs. When you configured node 2 to communicate with node 3, it could only "listen" to the inputs. Inputs can be read by more than one PLC. This is known as "multicast" inputs.

Therefore, since the second PLC does not control the outputs, but only "listens" to the inputs already being produced for the first PLC, the connection type for the second PLC is "multicast".

Test the Configuration

Now let's verify that your system is configured correctly.

Important: Make sure there is no blue text. This indicates that the edits have been accepted. If there is blue text, click on **Save** to save your edits again or ask an assistant for help.

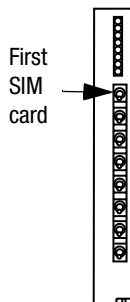

40940

- Place both processors in run mode.
- Flip up the first SIM card switch in the 1771-ACN(R)15 chassis. The first SIM LED in both PLC-5 chassis should light. If your system is not behaving in this manner, ask an instructor for assistance.

If your system is behaving correctly as described, you have completed the multicast discrete lab.

LAB 5: Analog I/O

ControlNet allows mapping of analog I/O in the same manner as discrete I/O. In this lab, you will configure the node 2 PLC-5 to consume (read) the analog input data being produced by the analog I/O module (1794-IE4XOE2) at node 4. You will also configure the PLC-5 to produce (write) analog output data which the 1794-IE4XOE2 will consume.

Let's start by adding the 1794-IE4XOE2 module back in the map table for node 2.

1. Use the keyswitch to put both PLC-5s in program mode.
2. You should still have the **Node 2 - PLC-5 ControlNet Configuration** screen open on your computer. If you do not, open the ControlNet Configuration tool for node 2.
3. Click on the **1794-ACN(R)15** entry (node 4) in the map table.
4. Click on the **Auto Module Selected Adapters** icon (shown below) from the toolbar.

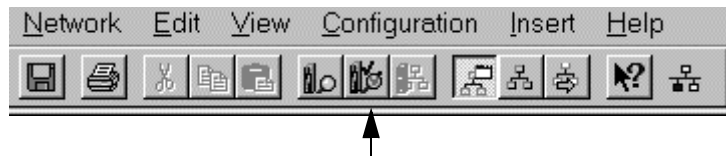

5. Click on **Yes** to the prompt to switch the software to edit mode.

A map entry for the 1794-IE4XOE2 appears below the 1794-ACN(R)15. Note that there is no node number to the left of the 1794-IE4XOE2, just a slot number. This slot number identifies the module as part of the 1794 chassis and not as a node on the network.

Also note that default sizes for the module were entered. This module has size 5 as an input size because it provides 4 analog inputs and 1 word of status. This module also has 2 analog outputs, so a size of 2 defaults in the Output Size field of the map table. All we have to do is tell the processor what data table locations to use.

6. Click on the **Auto Map All Entries** icon (shown below).

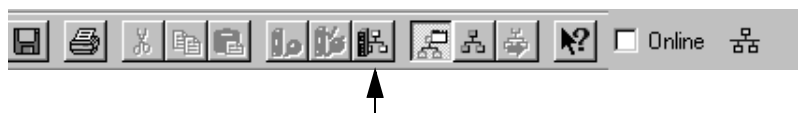

Notice that the DIF, DOF, and configuration files were automatically selected and the map entry for the 1794-IE4XOE2 was filled in using the newly selected files.

▶ DIF = Data Input File
DOF = Data Output File
A description of the purpose of these files is discussed in page 16.

7. Click on the **Network** option of the main menu.
8. Click on **Save** from the pull-down menu and then **OK** for an optimize schedule for all connections save.

That's all you have to do to configure the analog I/O module for communications. You don't need any ladder logic programming. Let's test the analog communications.

Test the Analog Communications

Important: Make sure there is no blue text. This indicates that the edits have been accepted. If there is blue text, click on **Save** to save your edits again or ask an assistant for help.

1. Place node 2 PLC-5 in run mode.
2. Turn the potentiometer above the 1794-IE4XOE2 module. As you turn the potentiometer, the meter above the potentiometer should also change. If your system is not behaving in this manner, ask an instructor for assistance.

If your system is behaving correctly as described, you have completed the analog lab.

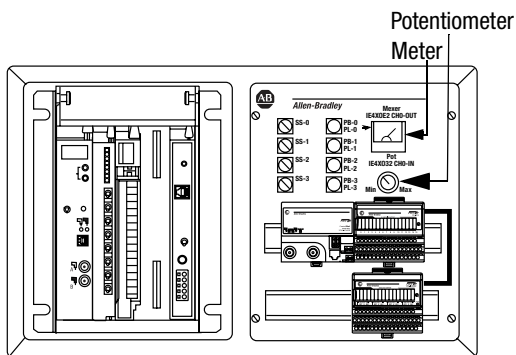

41265

LAB 6: Multicast Analog

ControlNet supports multiple PLCs reading analog data from the same module. In this lab, you will configure the PLC-5 at node 1 to listen to the analog inputs from the 1794-IE4XOE2/A module. Currently, the PLC-5 at node 2 is reading and writing to this module.

1. Place node 2 PLC-5 back in program mode.
2. Open the **Node 1 - PLC-5 ControlNet Configuration** screen (click on the node 1 button on the status bar).
3. Move the cursor over the **1794-ACN(R)15** entry in the map table and click the right mouse button.
4. Click **Insert Module** from the pull-down menu.
5. Click **Yes** to switch the software to edit mode. The **I/O Module** window box appears.

Notice that the 1794-IE4XOE2 module automatically appears in the “module type” box. This is because the software already knows that slot 0 has a 1794-IE4XOE2 module based on the map entry we entered for node 2. Also note that the “output size” field has been removed and the connection type is multicast. Once again, the software knows from the previous map entry that node 2 is the exclusive owner of this module.

6. Since all the defaults are correct, click on **OK**.
7. Click on the **Auto Map All Entries** icon from the toolbar.

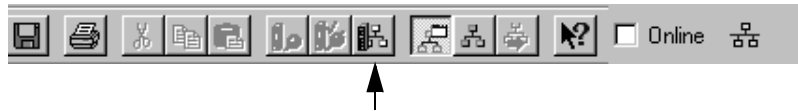

8. Look at slot 0 of node 4. It should already be selected. Your programmer has already entered a rung for this module which uses N12:20 as the input address. Select the input address field and change it to *N12:20*.
9. Click on the **Save** icon on the toolbar and then choose **OK** for an optimize schedule for all connections save.

That's it! You now have a second PLC-5 listening to the analog data from the 1794-IE4XOE2 module. Let's test your system.

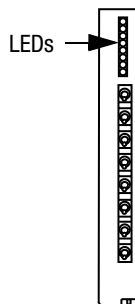

40940

Test System Configuration

1. Put node 1 PLC-5 in run mode.
2. Turn the potentiometer and observe the LEDs on the SIM card in the PLC-5 node 1 chassis. The last rung of the program moves N12:20 to the SIM LEDs. If your system is set up correctly, the SIM LEDs will toggle as you move the potentiometer.

If your system is not running as described, ask an instructor for help.

LAB 7: Scheduled Peer Communications

ControlNet allows mapping of peer devices, such as other PLCs, in the same manner as discrete I/O for high-speed PLC-to-PLC communication. In this lab, we will configure the two PLC-5s to exchange scheduled messages with each other automatically.

1. Put node 1 PLC-5 back in program mode.
2. Open the **Node 2 - PLC-5 ControlNet Configuration** screen.
3. Move the cursor over the **PLC-5** entry for node 1 in the map table.
4. Click the right mouse button. A pop-up menu appears.

5. Click on **Insert Receive Scheduled Message** from the pop-up menu.
6. Click on **Yes** to the prompt to switch the software to edit mode. The **Receive Scheduled Message** window appears.

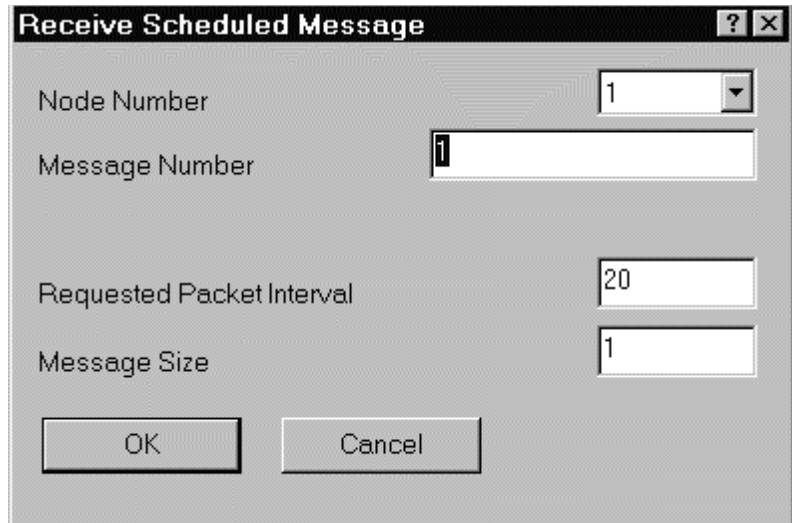

The screenshot shows a dialog box titled "Receive Scheduled Message". It has a standard Windows-style title bar with a question mark icon and a close button (X). The dialog contains the following fields and controls:

- Node Number:** A dropdown menu currently displaying the value "1".
- Message Number:** A text input field containing the value "1".
- Requested Packet Interval:** A text input field containing the value "20".
- Message Size:** A text input field containing the value "1".

At the bottom of the dialog, there are two buttons: "OK" and "Cancel".

The Node Number field already contains node 1; you don't have to change it. The node number defaulted to 1 since you pressed the right mouse button while the cursor rested on node 1.

The Message Number field allows you to uniquely identify a message. A system may have many scheduled messages configured. The way to identify each message is by its node and message number. Let's identify this message as message 5 (you could arbitrarily choose any number from 1 to 127).

7. Change the Message Number field to **5**.
8. Change the Message Size field to **10** (words).

9. Click **OK** to accept the message parameters. A “Receive Data From” entry appears in the map table.

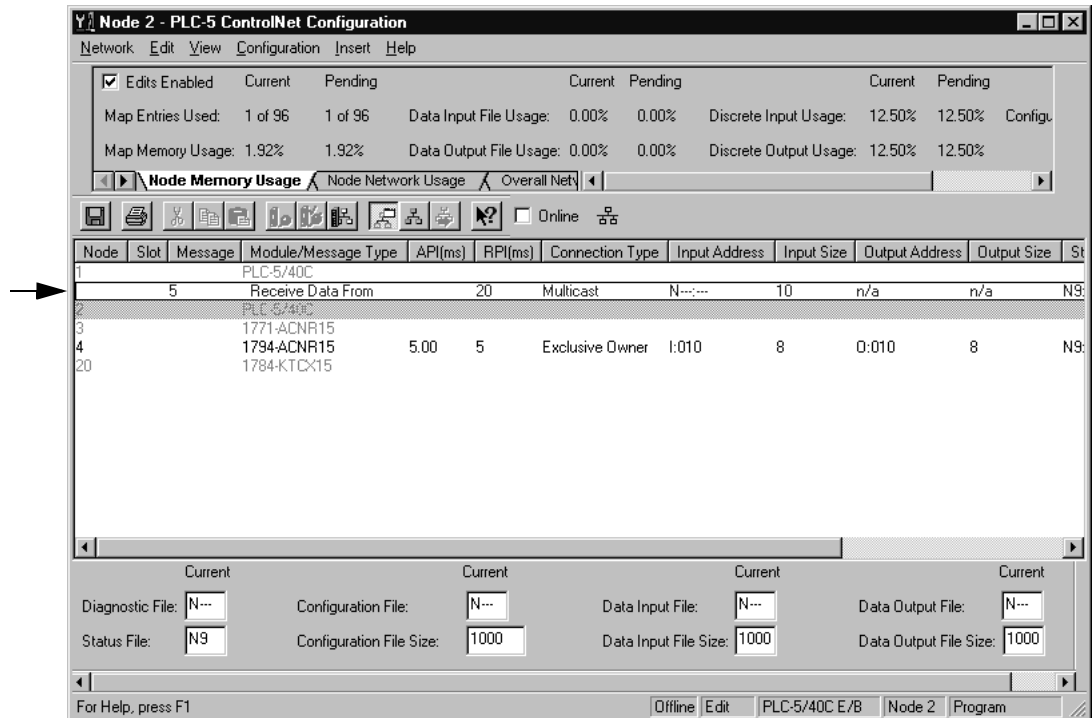

Note that the message appears under node 1 and has a message number of 5. By entering the “Receive Data From 1” in node 2 (from node 1), the software knows that node 1 must “produce” the data, and therefore, automatically enters a “Send Data” message (see below screen) in node 1. Let’s examine node 1.

10. Click on node 1 PLC-5 from the taskbar on the bottom of the screen.

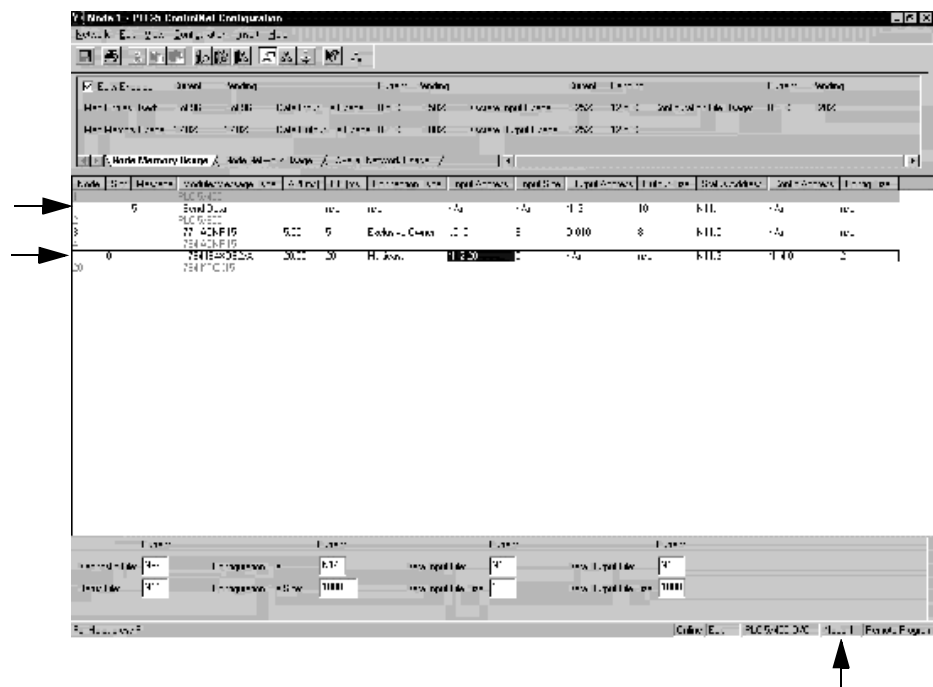

Notice that there is a “Send Data” message under node 1 using message number 5 (this send data matches the receive data just entered in PLC-5 node 2). Let’s also add a message receive in node 1.

11. Right click on node **2 PLC-5**. A pop-up menu appears.
12. Click on **Insert Receive Scheduled Message** from the pop-up menu. You see the **Receive Scheduled Message** window.
13. The Node Number field already contains node 2; you don’t have to change it.
14. Change the Message Number field to **3**.
15. Change the Message Size field to **15** (words).
16. Click on the **OK** button to accept the message parameters. A “Receive Data From” entry appears in the map table. Note that the message appears under node 2 and has a message number of 3. By entering the “Receive Data From 2” in node 1 (from node 2), the software knows that node 2 must “produce” the data, and therefore automatically enters a “Send Data” message in node 2. (You can click on the node 2 status bar to check for this entry.) The only thing you have to do is define the data table areas we wish to use.

Define Data Table Areas

1. Make sure you are on the **Node 1 - PLC-5 ControlNet Configuration** screen. Click on the **Auto Map All Entries** icon on the toolbar.

Node 1 is now mapped. Since you did not map node 2 previously, let’s go back to node 2 and map it.

2. Click on the **node 2 PLC-5** from the taskbar. The **Node 2 - PLC-5 ControlNet Configuration** tool appears. Now let’s map the message in node 2.

3. Click on the **Auto Map All Entries** icon on the toolbar.

Now that both processors are mapped, let’s accept the edits.

4. Click on the **Save** icon on the toolbar.
5. Click on **OK** for an optimize schedule for all connections save.

Note that edits in both processors will be accepted. Let’s test the messages.

Important: Make sure there is no blue text. This indicates that the edits have been accepted. If there is blue text, click on **Save** to save your edits again or ask an assistant for help.

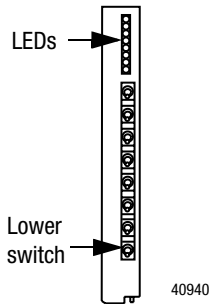

6. Put both processors in RUN mode.
7. Toggle the **lower** switch on the SIM card in both processor chassis and watch the LED on the opposite SIM card toggle.

Important: If node 1 SIMs still reflect the potentiometer, then turn the potentiometer all the way down. When the potentiometer is at the min setting, it is disabled in ladder logic.

If your system is not behaving as described, ask an instructor for assistance.

If your system is behaving as described, you have completed the peer messaging lab.

BONUS LAB: Communicate on ControlNet Using Ladder Instructions

ControlNet allows you to program event based communications in addition to scheduled communications. Event based communications are programmed using ladder logic.

Important: Since ladder logic instructions are event based, and not a part of the schedule entered in the PLC-5 ControlNet configuration table, they will use unscheduled bandwidth when transmitted on ControlNet.

The PLC-5 supports 2 ladder instructions for ControlNet communication: The message instruction (MSG) and the ControlNet I/O (CIO). The MSG instruction is used to transfer data between PLCs. The MSG instruction is the same instruction which has been used for years to transmit data on DH+. All you have to do is specify the ControlNet channel (channel 2) when entering the message parameters instead of the DH+ channel.

The CIO instruction is used to transfer data to or from an intelligent I/O module. Typical examples of intelligent I/O modules are analog modules, the 1771-SDN DeviceNet scanner module, and the 1771-DB basic programming module. The CIO functions identical to a block transfer instruction on remote I/O.

In this lab, we will add each type of instruction to the ladder program in PLC-5 node 1.

1. Open **RSLogix 5** software.
2. Click on **Comms** from the main menu.
3. Click on **System Comms** from the pull-down menu.
4. Set the processor node to *1*.
5. Make sure the AB_KTC-1 (Windows NT) or AB_KTC95-1 (Windows 95) driver is selected.

6. Click on the **Online** button.
7. If the **Going to Online Programming State** dialog box appears, click on the **Create New File** button.
8. Click on **Cancel** to the save prompt.

RSLogix 5 opens and you see the following screen:

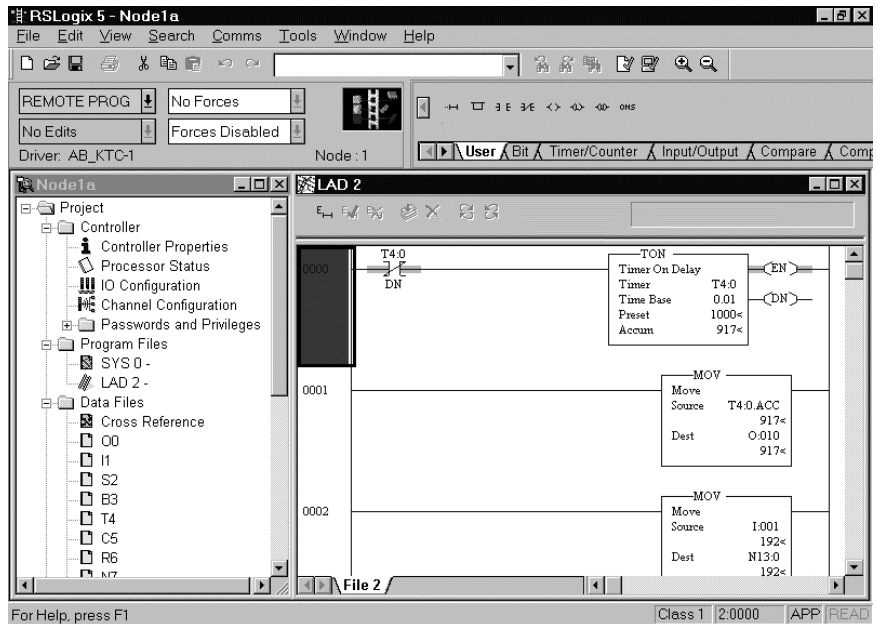

The first instruction you will add is a MSG instruction to read the system clock in node 2.

Enter the MSG Instruction

1. Put the PLC-5s in program mode.
2. Go to the last rung in the file (rung 0006) and double-click on the 0006 to the left of the rung. This will insert a new rung.
3. With the prompt at the start of the 0006 rung text edit box, type the following:

```
XIC I:012/0 MSG MG25:0
```

4. Press the Enter key.

An edit rung appears as shown below.

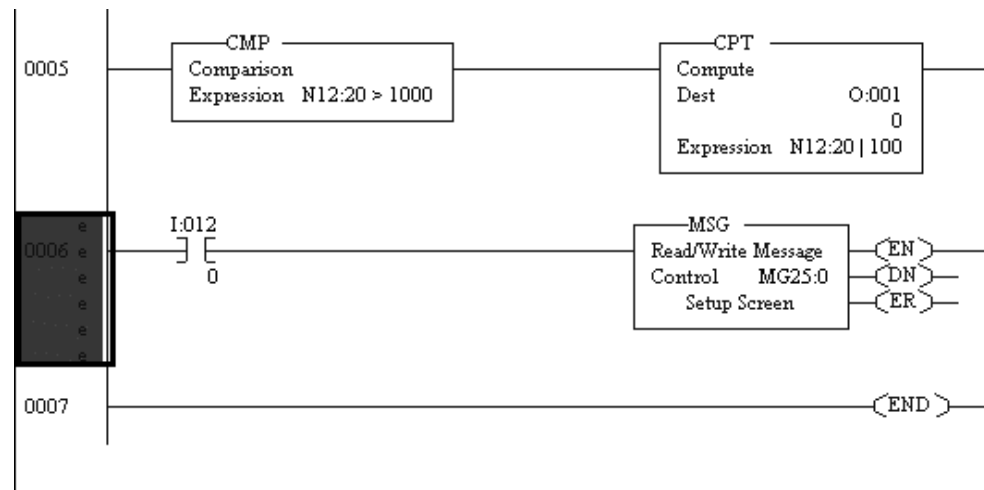

- Double-click on the Setup Screen inside the MSG instruction block.

You see this window:

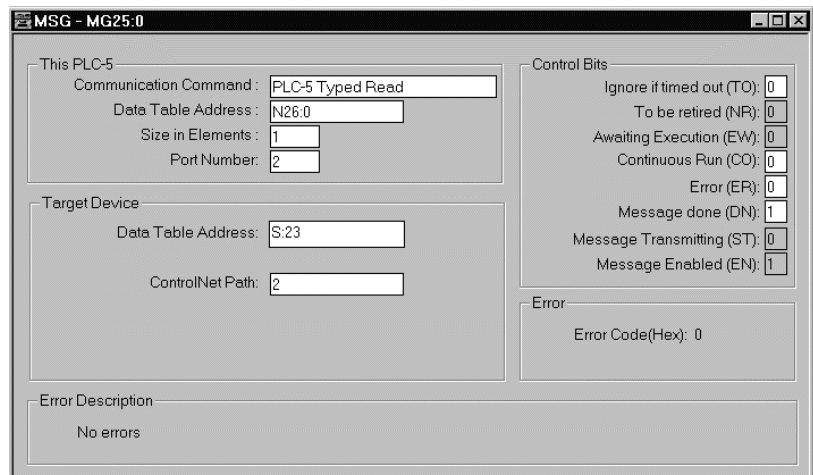

- Fill in the MSG window so that it matches the values shown in the window above.

This message will read the seconds part (S:23) of node 2's internal clock and store it in N26:0. Port number 2 specifies the ControlNet channel. The ControlNet path is where you enter the path to the device with which you want to communicate. Since you are communicating to a local ControlNet node, you only have to enter the node address.

- When you have finished entering the parameters for the message, click on the close screen icon (x) in the upper right part of the message screen.
- Click on rung number 0006 to highlight it.

- Press the right mouse button and click on **Accept Rung Edits** from the pop-up menu.

Test the MSG Rung

- Put node 1 PLC-5 in run mode.
- Turn the first switch (SS_0) above the FLEX adapter in the I/O box.
- Observe the message instruction. You should see the **-(DN)-** highlight.
- Double-click on file N26 in the left panel to open it.
- Toggle switch SS_0 and observe that the data in N26:0 updates.

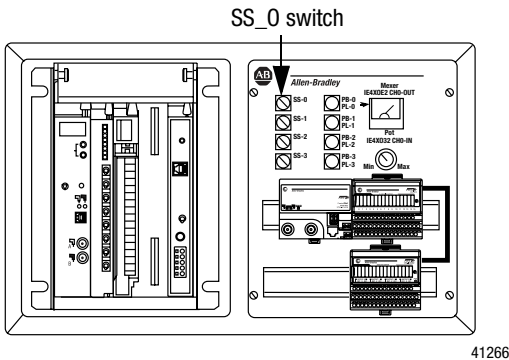

If your system is not behaving as described, ask an instructor for assistance.

Now that we have a message instruction working, let's add a CIO instruction to read the data in the 1771-DB module.

Enter the CIO Instruction

- Put node 1 PLC-5 back in program mode.
- Double-click on the 0007 (the rung number) to the left of the END rung (the last rung). This will insert a new rung.
- With the prompt at the start of the 0007 rung text edit box, type the following:

```
XIC I:012/I CIO CT27:0
```

- Press **Enter**.

An edit run appears as shown below.

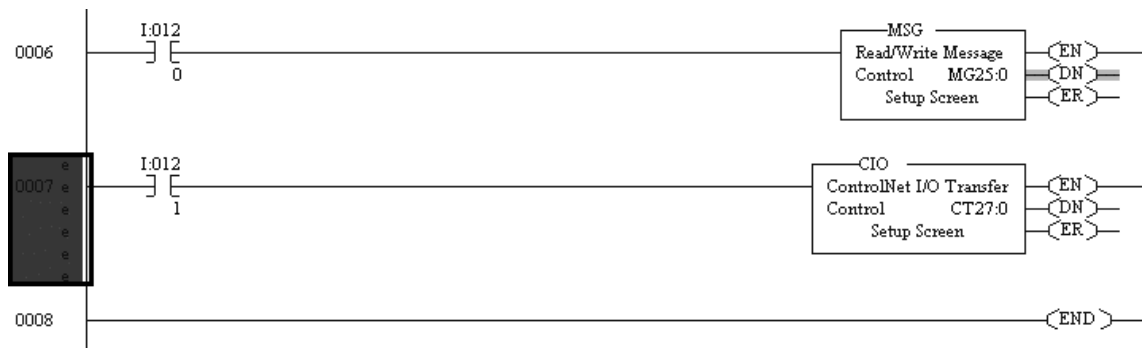

- Double-click on the Setup Screen inside the CIO instruction.

You see this screen:

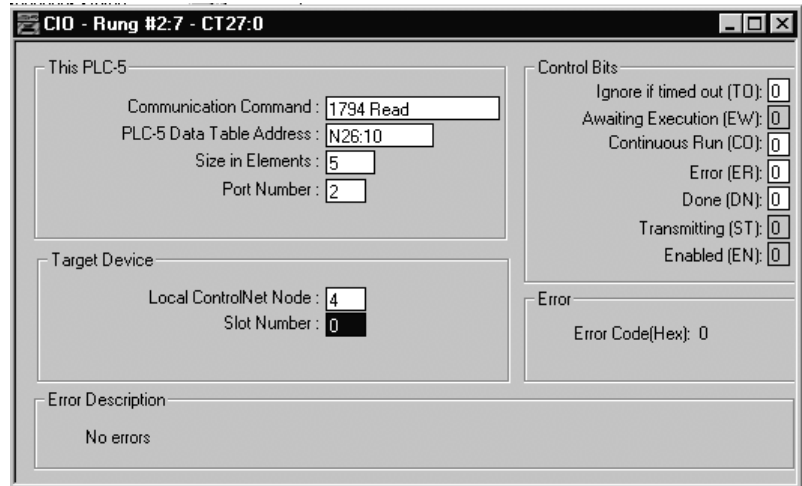

- Fill in the CIO window so that it matches the values shown in the window above.

This message will read the timing values being generated by the DB modules program and store them in N26:10-13. Port number 2 specifies the ControlNet channel. The local ControlNet node is where you enter the node address. The slot number identifies the physical slot in the chassis where the desired module resides.

- When you have finished entering the parameters for the CIO, click on the close screen icon (x) in the upper right part of the message screen.
- Click on rung number 0007 to highlight it.
- Press the right mouse button and choose **Accept Rung Edits** from the pop-up menu.

Test the CIO Rung

- Put node 1 PLC-5 in run mode.
- Turn the second switch (SS_1) above the FLEX adapter in the I/O box.
- Observe the CIO instruction. You should see the **-(DN)-** bit highlight.
- Double-click on file N26 in the left panel to open it.
- Toggle switch SS_1 and observe that the data in N26:10-11 updates.

If both of the ladder instructions are functioning correctly, then you have completed the ControlNet ladder instructions lab. If the ladder instructions are not functioning as described, ask an instructor for help.

ControlNet is a trademark of ControlNet International.

PLC-5 is a registered trademark of Rockwell Automation.

FLEX I/O is a trademark of Rockwell Automation.

RSLinx is a trademark of Rockwell Software, Inc.

Microsoft and Windows 95 are registered trademarks of Microsoft Corporation.

Windows NT is a trademark of Microsoft Corporation.



Rockwell Automation helps its customers receive a superior return on their investment by bringing together leading brands in industrial automation, creating a broad spectrum of easy-to-integrate products. These are supported by local technical resources available worldwide, a global network of system solutions providers, and the advanced technology resources of Rockwell.

Worldwide representation.



Argentina • Australia • Austria • Bahrain • Belgium • Bolivia • Brazil • Bulgaria • Canada • Chile • China, People's Republic of • Colombia • Costa Rica • Croatia • Cyprus • Czech Republic • Denmark • Dominican Republic • Ecuador • Egypt • El Salvador • Finland • France • Germany • Ghana • Greece • Guatemala • Honduras • Hong Kong • Hungary • Iceland • India • Indonesia • Iran • Ireland • Israel • Italy • Jamaica • Japan • Jordan • Korea • Kuwait • Lebanon • Macau • Malaysia • Malta • Mexico • Morocco • The Netherlands • New Zealand • Nigeria • Norway • Oman • Pakistan • Panama • Peru • Philippines • Poland • Portugal • Puerto Rico • Qatar • Romania • Russia • Saudi Arabia • Singapore • Slovakia • Slovenia • South Africa, Republic of • Spain • Sweden • Switzerland • Taiwan • Thailand • Trinidad • Tunisia • Turkey • United Arab Emirates • United Kingdom • United States • Uruguay • Venezuela

Rockwell Automation Headquarters, 1201 South Second Street, Milwaukee, WI 53204 USA, Tel: (1) 414 382-2000, Fax: (1) 414 382-4444

Rockwell Automation European Headquarters SA/NV, avenue Hermann Debrouxlaan, 46, 1160 Brussels, Belgium, Tel: (32) 2 663 06 00, Fax: (32) 2 663 06 40

Rockwell Automation Asia Pacific Headquarters, 27/F Citicorp Centre, 18 Whitfield Road, Causeway Bay, Hong Kong, Tel: (852) 2887 4788, Fax: (852) 2508 1846